

Išsiplėtimo indai

Išsiplėtimo indai šildymo sistemoms

Kodas	Info	Tūris (litrais)	Aukštis (mm)	Diametras (mm)	Ø Pajungimas	Viršslėgis (bar)	Slėgis max (bar)	Tmin / T max °C	Kaina
13G0000800	MB8	8	318	217	¾"	1	4.00	-10 / +99	23.36
13G0001200	MB12	12	334	267	¾"	1	4.00	-10 / +99	24.15
13G0001800	MB18	18	318	317	¾"	1	4.00	-10 / +99	25.73
13G0002500	MB25	25	398	317	¾"	1	4.00	-10 / +99	28.61
13G0003500	MB35S	35	478	368	¾"	1	4.00	-10 / +99	45.94
13G0003501	MB35	35	550	368	¾"	1	4.00	-10 / +99	48.56
13G0005000	MB50	50	585	418	¾"	1	4.00	-10 / +99	57.75
1300008007	MB80	80	636	450	¾"	1.5	6.00	-10 / +99	89.25
1300010506	MB105	105	693	500	¾"	2	6.00	-10 / +99	110.25
1300015006	MB150	150	925	500	¾"	2	6.00	-10 / +99	165.38
1300020007	MB200	200	840	600	¾"	2.5	6.00	-10 / +99	204.75
1300025009	MB250	250	975	630	¾"	2.5	6.00	-10 / +99	259.88
1300030009	MB300	300	1123	630	¾"	2.5	6.00	-10 / +99	317.63
1300040009	MB400	400	1495	630	¾"	2.5	6.00	-10 / +99	435.75
1300050009	MB500	500	1385	750	1"	2.5	6.00	-10 / +99	527.63
1300060008	MB600	600	1505	750	1"	2.5	6.00	-10 / +99	693.00
1300070005	MB700	700	1800	750	1"	2.5	6.00	-10 / +99	905.63
1300080002	MB800	800	1900	750	1"	2.5	6.00	-10 / +99	1008.00
1300090001	MB900	900	2150	750	1"	2.5	6.00	-10 / +99	1260.00

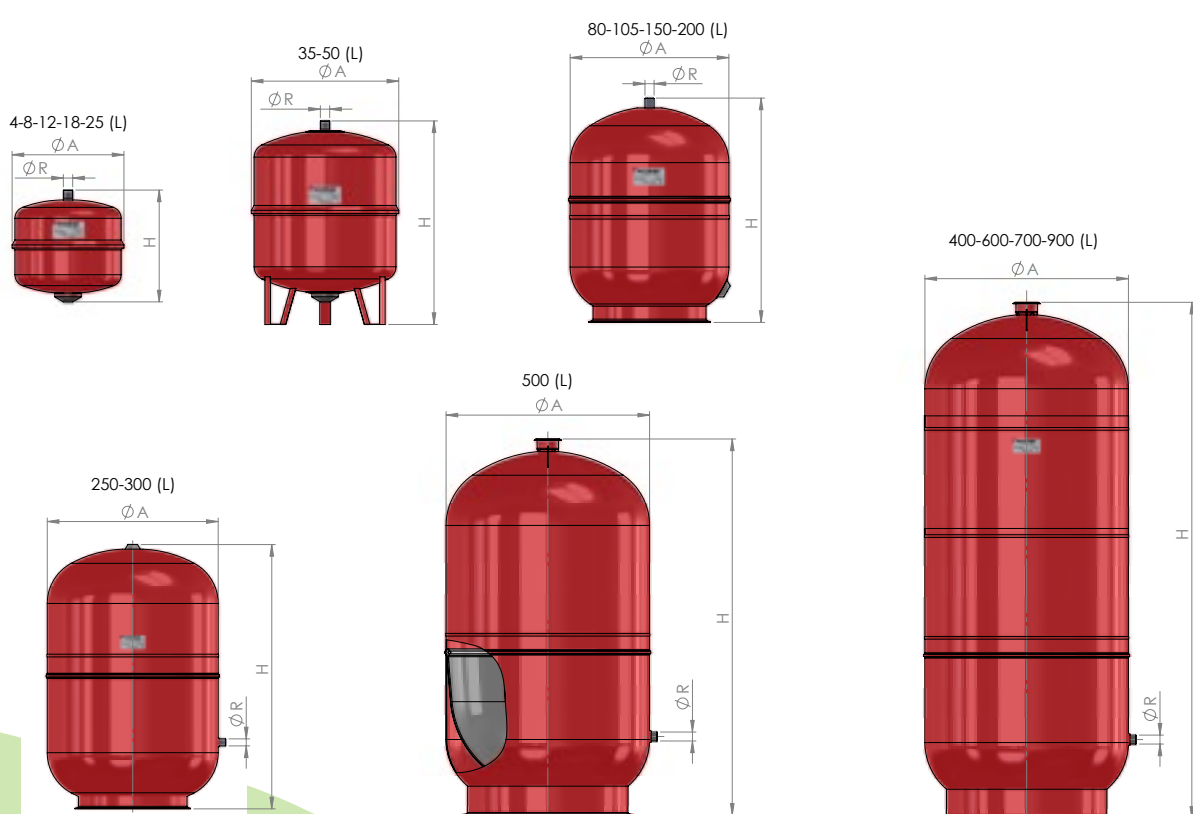

Išsiplėtimo indai

Išsiplėtimo indai geriamam vandeniui

Kodas	Info	Tūris (litrais)	Aukštis (mm)	Diametras (mm)	Ø Pajungimas	Viršslėgis (bar)	Slėgis max (bar)	Tmin / T max °C	Kaina
11A0000523	HY5	5	316	160	¾"	3	10.00	-10 / +99	27.50
11A0000836	HY8	8	326	200	¾"	3	10.00	-10 / +99	28.35
11A0001246	HY12	12	310	270	¾"	3	10.00	-10 / +99	30.98
11A0001835	HY18	18	395	270	¾"	3	10.00	-10 / +99	33.86
11A0002439	HY24	24	436	300	1"	3	10.00	-10 / +99	35.44

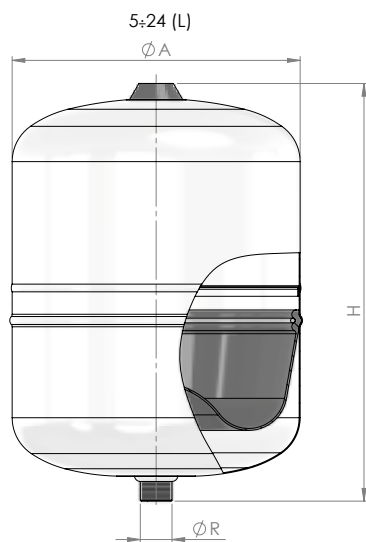

Išsiplétimo indai

Vertikalūs išsiplétimo indai hidroforams, priešgaisrinėms sistemoms

Kodas	Info	Tūris (litrais)	Aukštis (mm)	Diametras (mm)		Ø Pajungimas	Viršslėgis (bar)	Slėgis	Kaina
11000024F8	VHEF25	25	290	270	411	1"	1.50	10	31.24
1100005050	VHEF50	50	410	380	610	1"	1.50	10	97.13
1100006070	VHEF60	60	410	380	690	1"	1.50	10	115.50
1100008039	VHEF80	80	480	450	690	1"	1.50	10	139.13
1100010070	VHEF100	100	480	450	780	1"	1.50	10	181.13
1100020070	VHEF200	200	580	550	1075	1 1/2"	1.50	10	325.50
1100030066	VHEF300	300	660	630	1230	1 1/2"	1.50	10	391.13

8÷25 (L) VERT.



50÷100 (L) VERT.

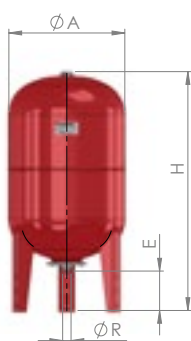

100R÷500(L) VERT.



750-1000(L) VERT.

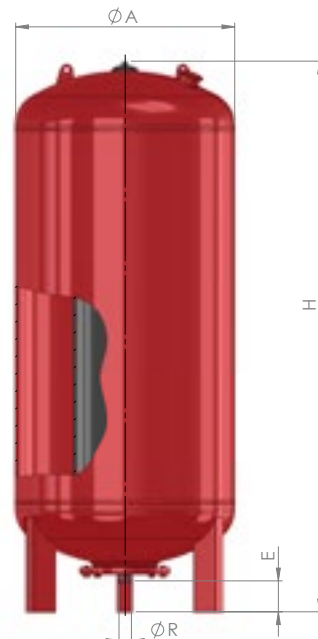

25 (L) HOR

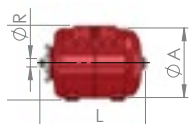

50÷100 (L) HOR

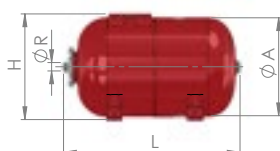

100R÷300 (L) HOR

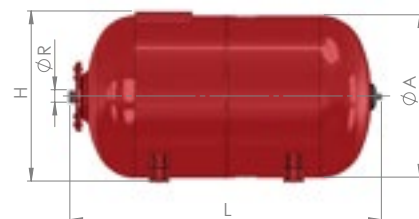

Išsiplētimo indai

Horizontalūs išsiplētimo indai hidroforams, priešgaisrinēms sistemoms

Kodas	Info	Tūris (litrais)	Aukštis (mm)	Diametras (mm)	L Išmatavimai (mm)	Ø Pajungimas	Viršslēgis (bar)	Slēgis	Kaina
11000024F9	VVEF25 SP	25	355	362	-	1"	1.50	10	25.46
11000024F7	VVEF25	25	411	270	-	1"	1.50	10	28.88
1100003501	VVEF35	35	420	380	-	1"	1.50	10	30.19
1100005049	VVEF50	50	790	380	180	1"	1.50	10	94.50
1100006068	VVEF60	60	880	380	170	1"	1.50	10	112.88
1100008038	VVEF80	80	850	450	153	1"	1.50	10	136.50
1100010069	VVEF100	100	930	450	153	1"	1.50	10	178.50
1100020069	VVEF200	200	1285	550	210	1 1/2"	1.50	10	330.75
1100030065	VVEF300	300	1415	630	188	1 1/2"	1.50	10	396.38
1100050062	VVEF500	500	1610	750	188	1 1/2"	1.50	10	666.75
1100075069/75/71	VVEF750	750	2125	750	150	1 1/2"	2.00	10	Klausti
1100100074/69/71	VVEF1000	1000	2150	850	120	1 1/2"	2.00	10	Klausti

